

TVS Diodes

Transient Voltage Suppression Diodes

SM8SxxCA Series



Description

Transient Voltage Suppressor (TVS) is a circuit protection component that either attenuates (reduces) or filters a transient voltage spike (overvoltage), TVS diodes provide critical protection by going into avalanche breakdown within no more than a few nanoseconds after a strike, clamping the transient voltage, and routing its current to the ground.

Applications

- Communication Equipment
- Security & Protection
- Industrial Control Equipment
- Power Supply
- Automotive Electronics
- New Energy
- Lightning Protection

Features

- AEC-Q101 Qualified
- Junction passivation optimized design passivated anisotropic rectifier technology
- $T_J = 175\text{ }^\circ\text{C}$ capability suitable for high reliability and automotive requirement
- Available in uni-directional polarity only
- Low leakage current
- Low forward voltage drop
- High surge capability
- Meets ISO16750-2 surge specification (varied by test condition)
- Meets MSL-1, per J-STD-020, LF maximum peak of $260\text{ }^\circ\text{C}$
- Compliant to RoHS directive 2011/65/EU and in accordance to WEEE 2002/96/EC

Functional Diagram

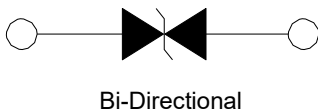

TVS Diodes

Transient Voltage Suppression Diodes

SM8SxxCA Series

Package Outline Dimensions (DO-218AB)

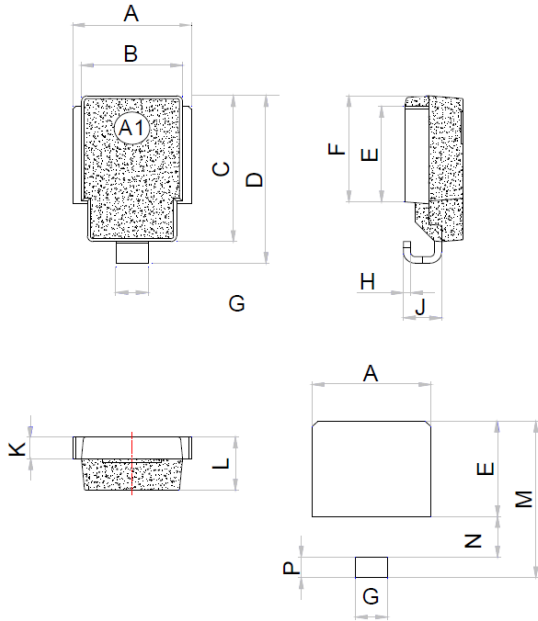

Symbol	Millimeters		Inches	
	Min.	Max.	Min.	Max.
A	9.5	10.5	0.374	0.413
B	8.3	8.7	0.327	0.342
C	13.3	13.7	0.524	0.539
D	15.0	16.0	0.592	0.628
E	8.5	9.1	0.335	0.358
F	9.5	10.1	0.374	0.398
G	2.4	3.0	0.094	0.118
H	0.5	0.7	0.020	0.028
J	2.7	3.7	0.106	0.146
K	1.9	2.1	0.075	0.083
L	4.7	5.1	0.185	0.201
M	14.2	14.8	0.559	0.583
N	3.5	4.1	0.138	0.161
P	1.6	2.2	0.063	0.087

Maximum Ratings and Characteristics

(Ratings at 25°C ambient temperature unless otherwise specified.)

Parameter	Symbol	Value	Unit
Peak pulse power dissipation on 10/1000 μ S waveform	P _{PPM}	6600	W
Peak pulse power dissipation on 10/10000 μ S waveform	P _{PPM}	5200	W
Peak Power Dissipation on Infinite Heat Sink at T _C =50 °C	P _D	8.0	W
Peak pulse current with 10/1000 μ S waveform	I _{PPM}	See page 5	A
Peak forward surge current, 8.3ms single half sine-wave	I _{FSM}	700	A
Operating junction and storage temperature range	T _J , T _{STG}	-65 to 170	°C
Typical Thermal Resistance Junction to Lead	R _{θJL}	0.9	°C / W
Typical Thermal Resistance Junction to Ambient	R _{θJA}	12	°C / W

Note:

1. Non-repetitive current pulse derated above TA = 25 °C .

TVS Diodes

Transient Voltage Suppression Diodes

SM8SxxCA Series

Part Numbering System

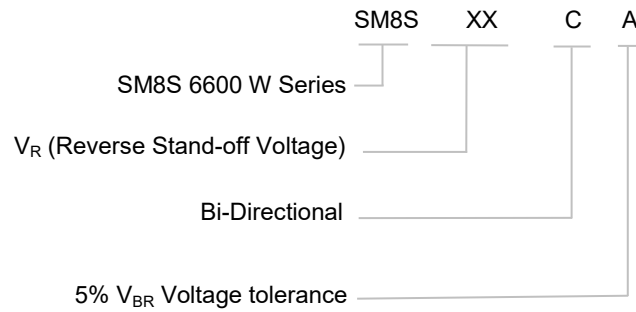

Marking

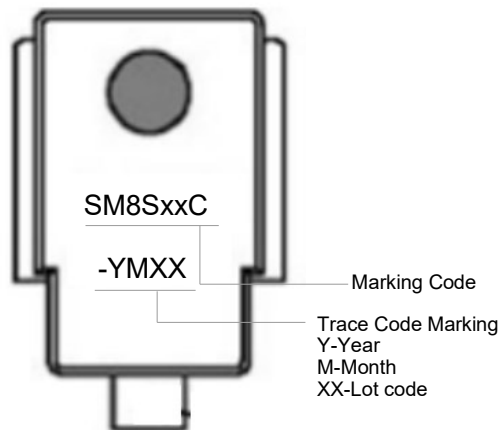

TVS Diodes

Transient Voltage Suppression Diodes

SM8SxxCA Series

Electrical Characteristics (T_A=25 °C unless otherwise noted)Table 1

Part Number	Breakdown Voltage V _{BR} @I _T		Test Current I _T	Reverse Stand-off Voltage V _R	Max. Reverse Leakage I _R @V _R		Max. Peak Pulse Current I _{PPM}	Max. Clamping Voltage V _C @I _{PPM}
	Min	Max			(μA @ 25 °C)	(μA @ 175 °C)		
Bi	(V)		(mA)	(V)	(μA @ 25 °C)	(μA @ 175 °C)	(A)	(V)
SM8S12CA	13.3	14.7	5	12	5	150	332	19.9
SM8S13CA	14.4	15.9	5	13	5	150	307	21.5
SM8S14CA	15.6	17.2	5	14	5	150	284	23.2
SM8S15CA	16.7	18.5	5	15	5	150	270	24.4
SM8S16CA	17.8	19.7	5	16	5	150	253	26.0
SM8S17CA	18.9	20.9	5	17	5	150	239	27.6
SM8S18CA	20.0	22.1	5	18	5	150	226	29.2
SM8S20CA	22.2	24.5	5	20	5	150	204	32.4
SM8S22CA	24.4	26.9	5	22	5	150	186	35.5
SM8S24CA	26.7	29.5	5	24	5	150	170	38.9
SM8S26CA	28.9	31.9	5	26	5	150	157	42.1
SM8S28CA	31.1	34.4	5	28	5	150	145	45.4
SM8S30CA	33.3	36.8	5	30	5	150	136	48.4
SM8S33CA	36.7	40.6	5	33	5	150	124	53.3
SM8S36CA	40.0	44.2	5	36	5	150	114	58.1
SM8S40CA	44.4	49.1	5	40	5	150	102	64.5
SM8S43CA	47.8	52.8	5	43	5	150	95.1	69.4

Performance Curve for Reference ($T_A=25^\circ\text{C}$ unless otherwise noted)

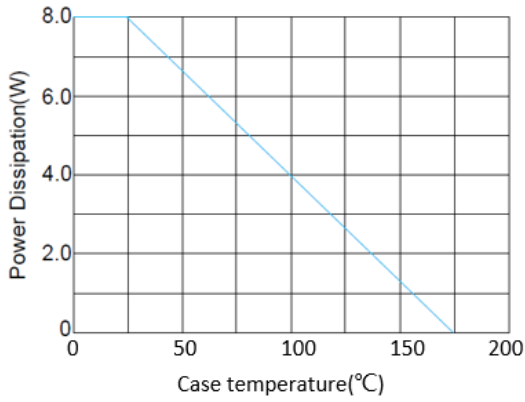

FIGURE 1
Power Derating Curve

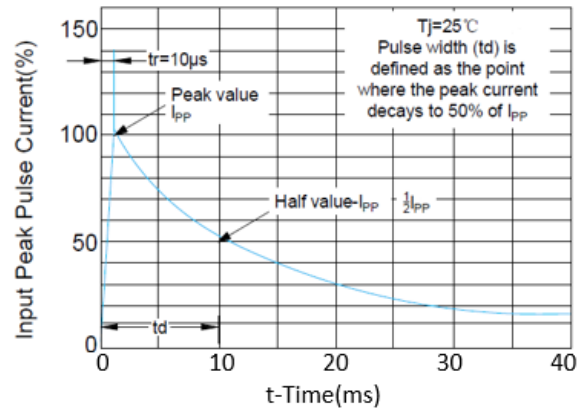

FIGURE 2
Pulse Waveform

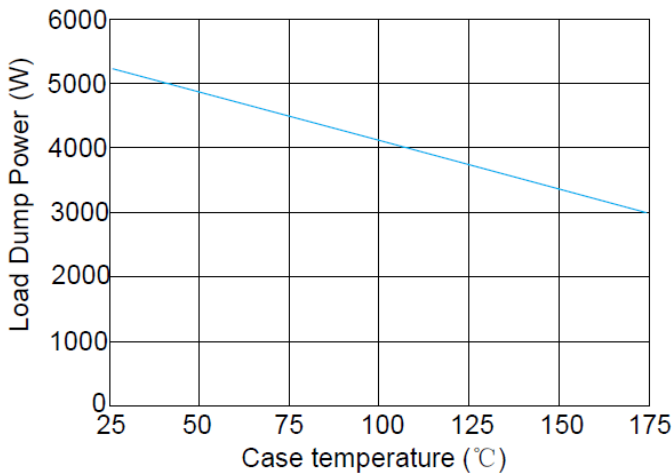

FIGURE 3
Load Dump Power Characteristics
(10 mS Exponential Waveform)

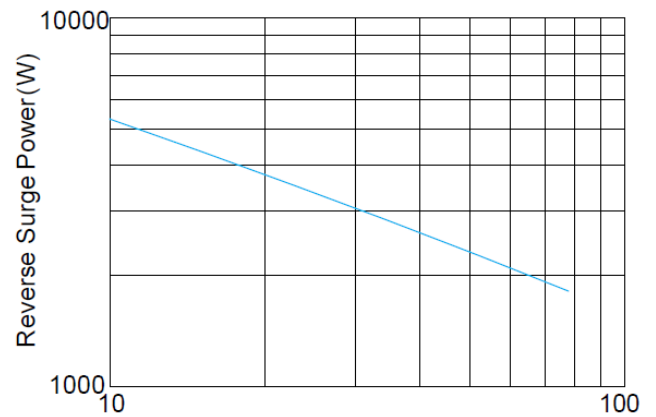

FIGURE 4
Reverse Power Capability

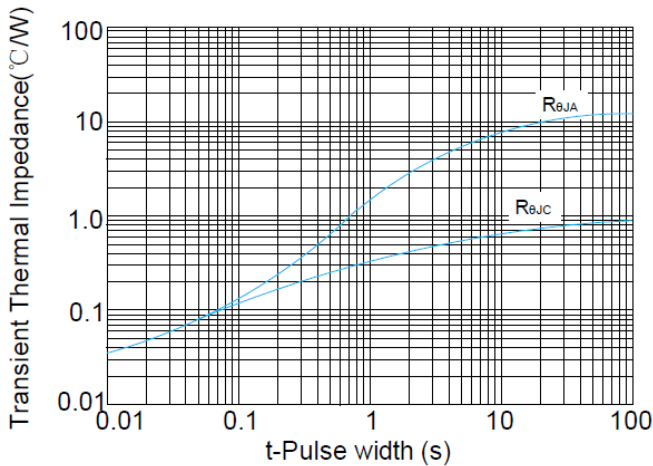

FIGURE 5
Typical Transient Thermal Impedance

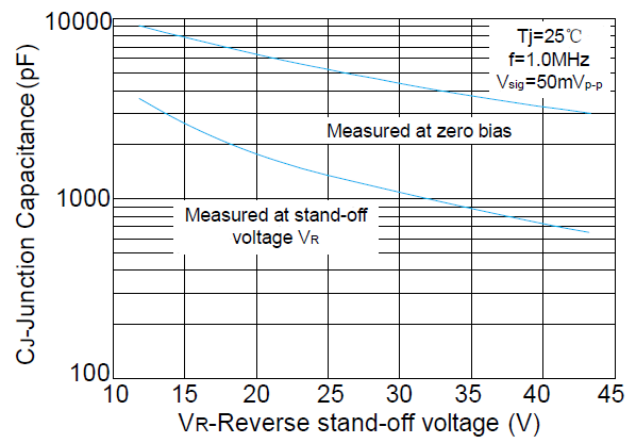
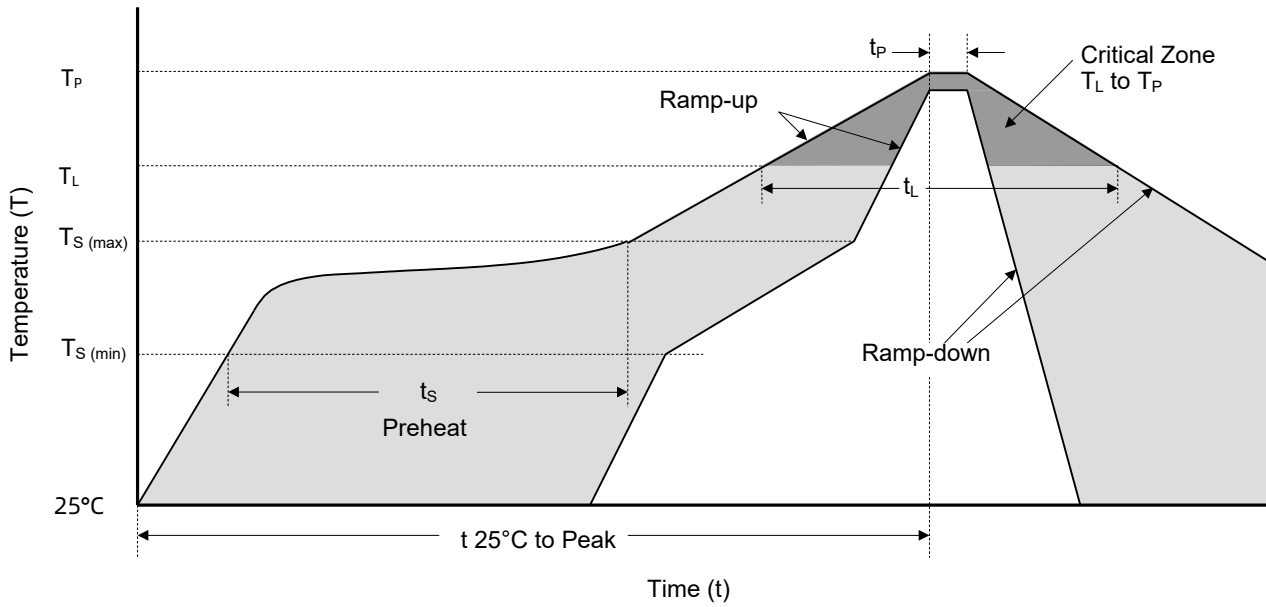

FIGURE 6
Typical Junction Capacitance

Soldering Parameters



Reflowing Condition

Reflow Soldering Parameters		Lead-Free Assembly
Pre-heat	Temperature Min ($T_{S (min)}$)	150 °C
	Temperature Max ($T_{S (max)}$)	200 °C
	Time (min to max) (t_s)	60 ~ 180 seconds
Average Ramp Up Rate (Liquidus Temp (T_L) to Peak)		3 °C / second max.
$T_{S (max)}$ to T_L Ramp-up Rate		3 °C / second max.
Reflow	Temperature (T_L) (Liquidus)	217 °C
	Time (min to max) (t_L)	60 ~ 150 seconds
Peak Temperature (T_P)		260 ^{+0/-5} °C
Time of within 5 °C of Actual Peak Temperature (t_p)		20 ~ 40 seconds
Ramp-down Rate		6 °C / second max.
Time from 25 °C to Peak Temperature		8 Minutes max.
Do Not Exceed		260 °C

TVS Diodes

Transient Voltage Suppression Diodes

SM8SxxCA Series

Packaging Information

Tape	Symbol	Dimension	
		Millimeters	Inches
	A ₀	10.80 ± 0.30	0.425 ± 0.012
	B ₀	16.13 ± 0.30	0.635 ± 0.012
	C	330.00 ± 0.30	13.000 ± 0.012
	D ₀	1.55 ± 0.20	0.061 ± 0.008
	D ₁	1.55 ± 0.20	0.061 ± 0.008
	E	1.75 ± 0.20	0.069 ± 0.008
	E ₁	13.30 ± 0.20	0.524 ± 0.008
	F	11.50 ± 0.20	0.453 ± 0.008
	P ₀	4.00 ± 0.20	0.157 ± 0.008
	P ₁	16.00 ± 0.20	0.630 ± 0.008
	P ₂	2.00 ± 0.20	0.079 ± 0.008
	W	24.00 ± 0.20	0.945 ± 0.008
	W ₁	25.85 ± 0.20	1.018 ± 0.008

Part Number	Package	QTY (Reel)	Packaging Option	Packaging Specification
SM8SxxCA	DO-218AB	750 PCS	Tape & Reel 13" reel	EIA STD RS-481

Glossary

Item	Description
V_C	Clamping Voltage Voltage across TVS in a region of low differential resistance that serves to limit the voltage across the device terminals.
V_R	Reverse Stand-off Voltage Maximum voltage that can be applied to the TVS without operation. NOTE : It is also shown as V_{WM} (maximum working voltage (maximum d.c. voltage)) and known as rated stand-off voltage (V_{SO}).
I_R	Reverse Leakage Current Current measured at V_R . NOTE : Also shown as I_D for stand-by current.
V_{BR}	Breakdown Voltage Voltage across TVS at a specified current I_T in the breakdown region.
I_{PPM}	Rated Random Recurring Peak Impulse Current Maximum-rated value of random recurring peak impulse current that may be applied to a device.
$P_{M(AV)}$	Rated Average Power Dissipation Maximum-rated value of power dissipation resulting from all sources, including transients and standby current, averaged over a short period of time.
P_{PPM}	Rated Random Recurring Peak Impulse Power Dissipation Maximum-rated value of the product of rated random recurring peak impulse current (I_{PPM}) multiplies by specified maximum clamping voltage (V_C).
C_J	Capacitance Capacitance across the TVS measured at a specified frequency and voltage.
V_{FS}	Peak Forward Surge Voltage Peak voltage across an TVS for a specified forward surge current (I_{FS}) and time duration. NOTE : Also shown as V_F .
I_{FS}	Forward Surge Current Pulsed current through TVS in the forward conducting region. NOTE : Also shown as I_F .
$\alpha_{V(BR)}$	Temperature Coefficient of Breakdown Voltage The change of breakdown voltage divided by the change of temperature.
I_{PP}	Peak pulse Current Peak pulse current value applied across the TVS to determine the clamping voltage V_C for a specified wave shape.
I_T	Pulsed D.C. Test Current Test current for measurement of the breakdown voltage V_{BR} . This is defined by the manufacturer and usually given in milliamperes with a pulse duration of less than 40 ms. NOTE : Also shown as I_{BR} .

—(GB-T 18802.321 / IEC 61643-321 / JESD210A)



ATTENTION

Usage

1. TVS must be operated in the specified ambient temp.
2. Do not clean the TVS with strong polar solvent such as ketone, esters, benzene and halogenated hydrocarbon, to avoid damaging the encapsulating layer.
3. Please do not apply severe vibration, shock or pressure to TVS, to avoid element cracking.

Replacement

1. If TVS is visually damaged, please replace it.
2. TVS is a non-repairable product. For safety sake, please use equivalent TVS for replacement.

Storage

1. Storage Temp. Range: (-55 to 150) °C.
2. Do not store the TVS at the high temp., high humidity or corrosive gas environment, to avoid influencing the solder-ability of the lead wires. The product shall be used up within 1 year after receiving the goods.

Environmental Conditions

1. TVS should not be exposed to the open air, nor direct sunshine.
2. TVS should avoid rain, water vapor or other condition of high temp. and high humidity.
3. TVS should avoid sand dust, salt mist, or other harmful gases.







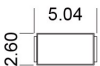

Max. Typical Capacitance of TVS

The typical capacitance of TVS is listed in the specifications. Designers may refer to it when designing TVS in High frequency circuit.

Installation Mechanical Stress

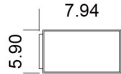
1. Do not knock TVS when installing, to avoid mechanical damage.
2. Please do not apply severe vibration, shock or pressure to TVS, to avoid surface resin or element cracking.

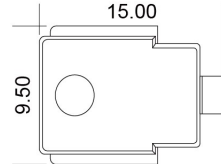
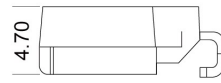
Automotive TVS Diodes (Surface Mount) Feature Overview

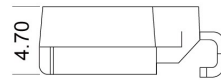
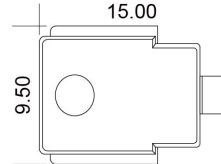
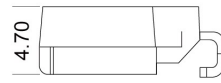
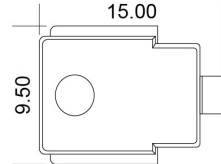
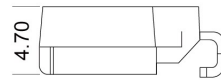
Package Type	Series													
	DO-214AA	DO-214AB	DO-214AC	DO-218AB	ASMB	ASMB-VR	ASMC	ASMC-VR	ASMD	A5.0SMD	SM8SxxA	SM8SxxCA	SM8TxxA	SM8TxxCA
Product Outline (mm)														
V_R / V_{WM} (V) Reverse Stand-off Voltage	5.8 ~ 468	5.0 ~ 440	5.8 ~ 553	5.0 ~ 440	5.8 ~ 51	5.0 ~ 440	12.0 ~ 170	10.0 ~ 43.0	12.0 ~ 43.0	20.0 ~ 43.0	33.0 ~ 36.0			
P_{PPM} (W) (10/1000 μ s) Rated Peak Impulse Power Dissipation	400	600	1500	3000	5000	6600	8000							
Operating Temperature (°C)	-55 to +150						-55 to +175							